



## 10.0 kW Ground Mount PV System\*

Ground Mount  
Modular

Data Specifications, Part SLR-GRD-10000

*Energizing the Future*



[www.patriotsolargroup.com](http://www.patriotsolargroup.com)

Patriot Solar Group (PSG) manufacturing and engineering for the renewable world. We are committed to providing the highest quality products and service in the industry. Our dedicated sales, engineering, and operations staff keeps the customer and the environment at the forefront of their minds while creating a customized solution to fit your renewable needs. PSG will work hand in hand with you from the conception of the project until completion. If you are in the market for a renewable solution and want more than "just a supplier" look to PSG for your manufacturing and engineering needs.

All Patriot Solar mounts are designed to withstand high wind-loading. This gives Patriot the ability to offer our customers and installers, quality and peace-of-mind that the system will assemble together fast and efficient.



### Features/Benefits:

- ▶ Modular with quick assembly
- ▶ 3-piece, pounded post design (post, truss and supporting beams)
- ▶ Mill finished rails designed for exact panel fit
- ▶ Ideal for large commercial and utility-scale installations
- ▶ Perfect for MW and multi-MW systems
- ▶ Rugged, Weather Resistant Designs
- ▶ 10-year guarantee against mechanical failure (breakage) of the frame construction

# 10.0 kW Ground Mount PV System\*

Ground Mount  
Data Specifications



www.patriotsolargroup.com

## Mechanical Data

Type	Fixed
Length	10 sections, approx. 161in (4.1m) each, expandable up to utility-scale
Height	48in - 78in (1.2m - 2m)
Width	26in - 46in (.7m - 1.2m) panel mounting holes
Wind Survival	90 mph (144.8 kmph)
Quantity of Modules (based on 1.6m <sup>2</sup> modules)	4 between posts
Rails	2 per section
Module Orientation	Portrait
Tilt Angle	30° - 45° per customer specification

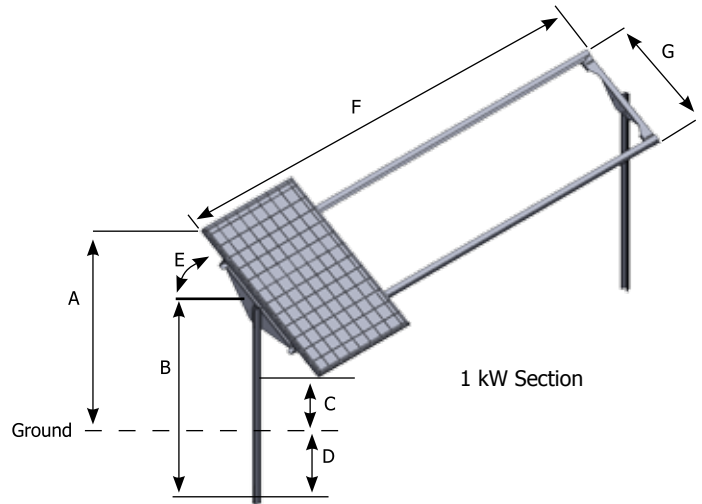

A	48in - 78in (1.2m - 2m)	E	30° - 45°
B	77in (2m)	F	161in (4.1m)
C	18in - 36in (.5m - .9m)	G	26in - 46in (.7m - 1.2m)
D	36in - 48in (.9m - 1.2m)		

## Shipping Data

Shipping weight (lbs)	1500lbs (680.4kg)
Shipping Dimensions**	2 - 163in x 24in x 8in skids (4.1m x .6m x .2m)

- ▶ Post is steel grade 80,000psi minimum yield strength

## Warranty

- ▶ Ten (10) years against mechanical failure of the frame construction

Patriot Solar Group's Solar Mounts are warranted to be free from defects in material and workmanship under normal use and service. Patriot Solar Group shall repair or replace defective equipment, at no charge, or at its option, refund the purchase price, if the equipment is returned to Patriot Solar Group not more than ten (10) years after shipment. Removal or re-installation of equipment and its transportation shall not be at cost of Patriot Solar Group except Patriot Solar Group shall return repaired or replaced equipment freight prepaid. Complete warranty available on our Web site: [www.patriotsolargroup.com](http://www.patriotsolargroup.com)

All specifications subject to change without notice.

\*Based on 994mm x 1640mm x 46mm 250w Panels

\*\*Shipping dimensions are based on current shipping practices and subject to change without notice.

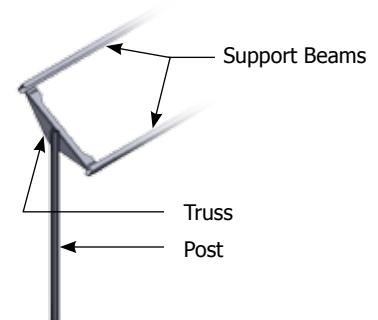

For further information please contact:

Patriot Solar Group  
1007 industrial Avenue  
Albion, Michigan 49224 USA

Tel: (01) 517 629 9292  
Fax: (01) 517 629 9296  
info@patriotsolargroup.com

[www.patriotsolargroup.com](http://www.patriotsolargroup.com)

Patriot Solar Group is dedicated to providing the highest quality units using only the best materials for solar and lighting products for home and commercial use that support renewable energy. Our products are environmentally safe, efficient, and affordable while offering the peace of mind of high durability able to withstand the ravages of wind, ice, and water. Our manufacturing processes are based on automotive quality standards to ensure high quality and reliability the first time.

DATA900506\_REV001